



FLOTTWEG CENTRIFUGE TECHNOLOGY FOR THE EXTRACTION OF AVOCADO OIL

Satisfying Customer Needs by Using
High Quality Separation Technology



FLOTTWEG TECHNOLOGY FOR THE PRODUCTION OF AVOCADO OIL

Efficient Centrifuge Technology Made by Flottweg

Not so long ago, an avocado was an indicator of luxury and well-being, nowadays this view has changed due to a widespread use and purpose of this green fruit with the highest fat content of all known fruit and vegetable varieties. Today, the avocado is often used as a raw material for pharmaceutical or cosmetic purposes, or even for cooking as a natural cooking oil.

These arguments show that avocado is becoming increasingly important for modern industries. The production of avocado oil is similar to the production of olive oil where Flottweg Technology is the benchmark and convinces customers all over the world with its outstanding performance.

FLOTTWEG TECHNOLOGY FOR THE EXTRACTION OF AVOCADO OIL

- Tricanter® for three-phase separation of avocado oil, fruit flesh and water
- Separator for purifying avocado oil

PROCESSING AVOCADO OIL USING THE FLOTTWEG TRICANTER® AND SEPARATOR

The Tricanter® separates the avocado pulp into the fruit pulp, oil and water phases (more about the process itself on page 3). Then, the separator purifies the oil phase and removes ultrafine impurities. This process is gentle to the product and is appropriate for producing the highest grade of avocado oil. Processing with Flottweg Separation Technology results in a high oil yield and clear avocado oil, in other words: in highest possible yield and customer satisfaction.

THE FLOTTWEG SEPARATOR WITH SOFT SHOT® DISCHARGE SYSTEM

The Flottweg Separator is available in the following configurations:

- Clarifier: for continuous separation of solids from liquids
- Clarifier with hydrohermetic system: For clarification of products that are susceptible to oxidation
- Purifier: for separation of three-phase mixtures comprising two immiscible liquid phases and one solid phase



The Flottweg Tricanter® and its customer benefits

- Highest possible purity of the liquids to be separated by using the impeller
- Experience of more than 40 years enables maximum continuity, versatility and performance
- Other processing / separating stages can be dispensed with, or are no longer required, thereby offering cost savings for the plant owner
- Adaptation to changing conditions (product in the feed) possible at any time
- Automation is possible
- Developed and manufactured in Germany, for the highest possible production quality

The Flottweg Soft Shot® discharge system and its advantages

- Solid discharge operations that make hardly any noise
- Precise partial or full discharges in any combination for maximum product yield
- Reduced wear on the highly loaded components
- Reduced number of bowl seals
- Meet an extremely wide range of customers' requirements because of variable control of the separator



FLOTTWEG TECHNOLOGY FOR PROCESSING AVOCADO

The Process of Obtaining High-Quality Avocado Oil

WASHING AND CRUSHING

After being harvested, avocados are cleaned properly to remove leaves, soil and other impurities, which in turn makes it possible to obtain a high-quality oil in the end of the process. After cleaning, a mash is produced by crushing the avocados together with the avocado stones. Whether you're processing entire avocados or depitted ones, Flottweg Centrifuges provide the optimum separation performance.

MALAXING

The produced mash is conveyed to the malaxer or kneading mill. Through malaxing, the oil is released from the oil cells by which it is encapsulated. Moreover, the malaxing procedure is critical for oil yield and oil quality.

SEPARATION

After malaxing, the mash is pumped to a Flottweg Decanter/Tricanter® (2-phase/3-phase) for separation. As a result, the mash is separated into oil, fruit water and solids (3-phase). Additionally, dilution water is added to the feed, in order to fluidize the mash. In contrast to the 3-phase process, in the 2-phase process using a Flottweg Decanter, the mash is separated into oil as liquid phase and solid phase (pomace). The 2-phase process requires neither or a minimum amount of dilution water to the feed, depending on the moisture content of the raw material.



Flottweg Separator
AC 1500 for obtaining
high-quality avocado oil

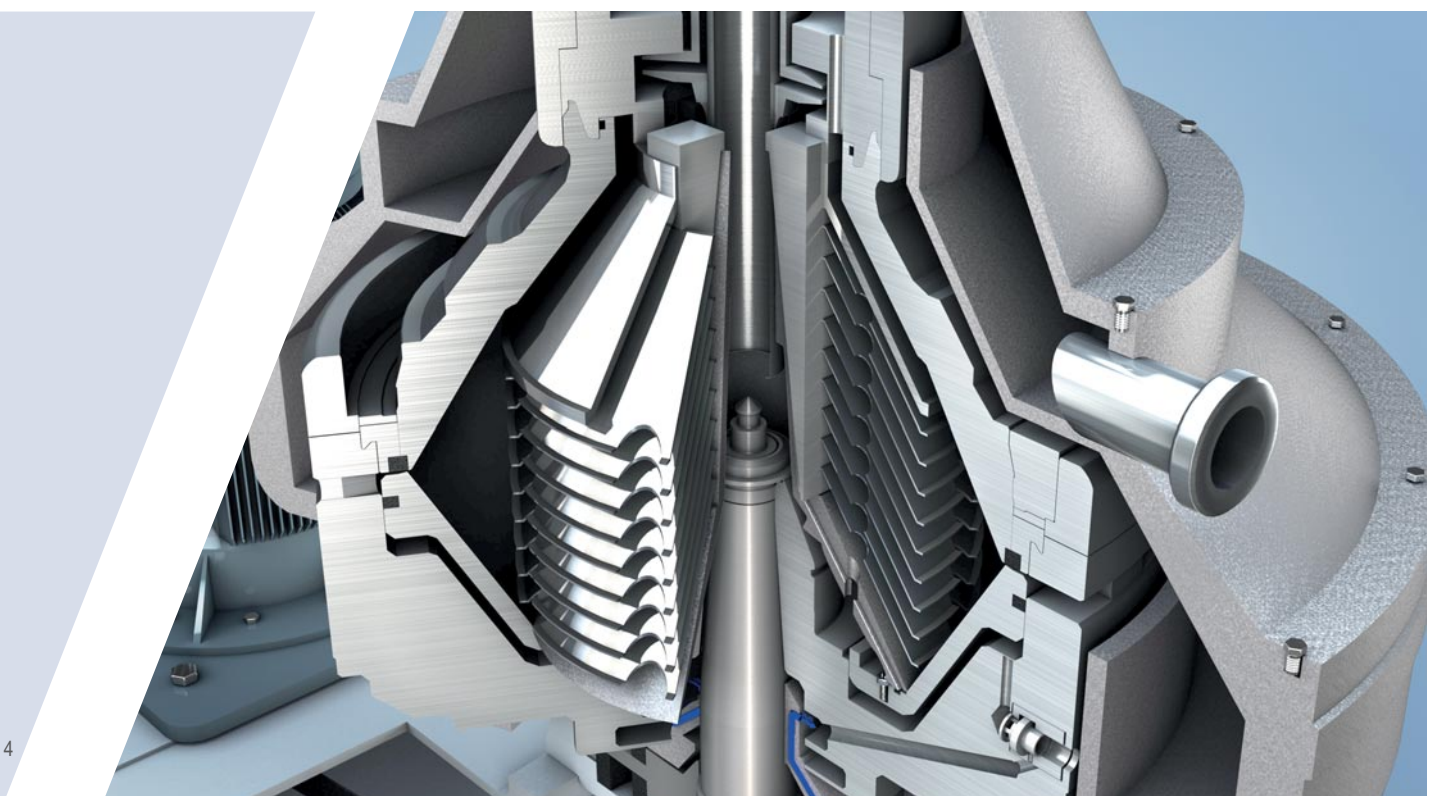

PURIFICATION

The oil coming from a Flottweg Decanter/Tricanter®, is then polished via a Flottweg Separator and represents the final step of the process. This enables to separate the oil from any residual solids and water applying a significantly higher g-force than a decanter/Tricanter®, so that high-quality avocado oil results.

The decision whether to apply 2- or 3-phase processing depends on local as well as on individual circumstances. However, Flottweg provides competent support to achieve the best possible performance.

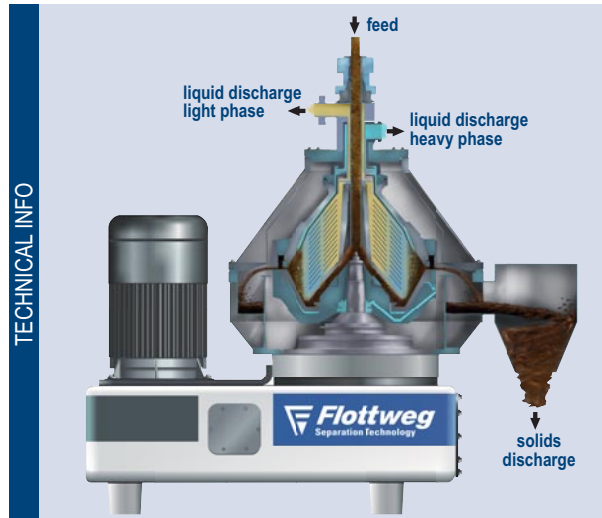

Flottweg Separator for the separation of two immiscible liquids with simultaneous separation of solids

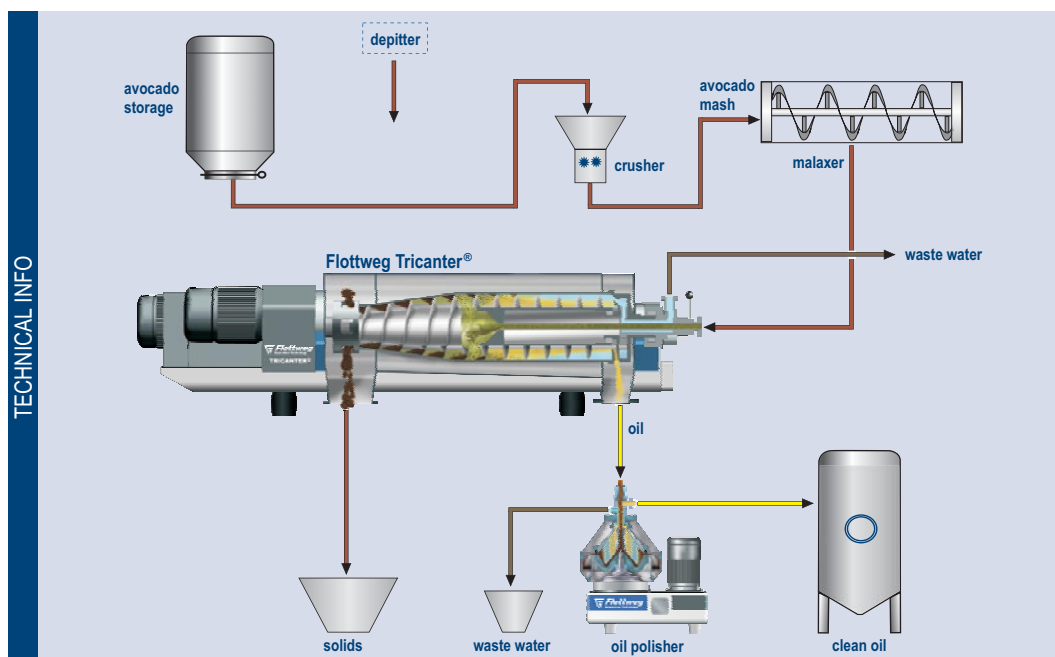

The process of getting high-quality avocado oil



OPERATING PRINCIPLE 2-PHASE

The Flottweg Decanter

FEED

The product is fed through a stationary pipe into the feed zone located in the center of the rotating assembly. The product is then accelerated circumferentially and delivered through ports in the scroll into the bowl.



SCROLL

The scroll rotates with a slightly different speed than the bowl and conveys the separated solids towards the conical end of the bowl. This differential speed determines the residence time of the solids in the bowl. Residence time is a critical factor for cake dryness. It can be automatically adjusted by changing the differential speed of the scroll thus providing optimal separation. Depending on the physical properties of the product, Flottweg Decanters can be supplied with a different scroll design or by modifying an existing scroll. Scroll pitch and single or multiple lead configurations are important design variables.



BOWL

The bowl has a cylindrical and conical section. The rotational speed is pre-set optimally to the application and requirements. The slurry rotates with the bowl at the operating speed and forms a concentric layer on the bowl wall. The solids contained in the product are packed against the bowl wall by centrifugal force. The length of the cylindrical bowl section and the cone angle are selected to meet the specific requirements of an application.

SOLIDS DISCHARGE

Settled solids are ejected through ports at the conical end of the bowl into the solids housing and fall vertically through the discharge chute.

TECHNICAL INFO

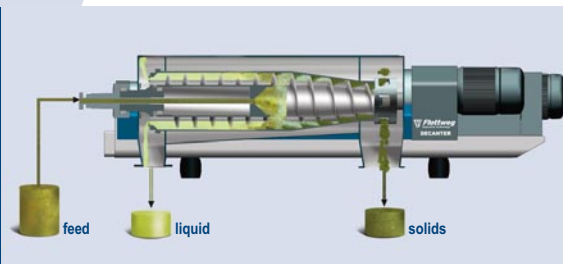

Flow of liquids and solids in a Flottweg Decanter



OVERFLOW WEIRS

The clarified liquids flow to the cylindrical end of the bowl where they exit over weir plates. Easily adjustable weir plates allow for precise adjustment of the pond depth in the bowl. The liquid overflow is then collected in a centrate chamber and discharged by gravity.

The picture shows a decanter scroll

OPERATING PRINCIPLE 3-PHASE

The Flottweg Tricanter®

The Flottweg Tricanter® performs a three-phase separation, i.e. the simultaneous separation of two immiscible liquids with different densities and one solid phase, provided that the solid phase is the heaviest

phase. The main difference from a decanter is the separate discharge of the two liquid phases.

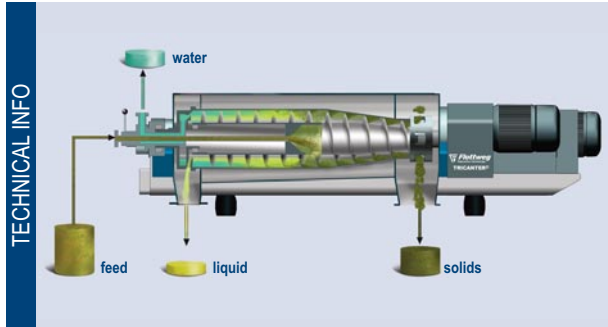

Flow of liquids and solids in a Flottweg Tricanter®



Customer benefits of the variable impeller

- Immediate adjustment of the pond depth and liquid-liquid separation zone
▶ optimum results
- Savings in costs due to the needlessness of a separate chamber pump
- Easy reading of the variable impeller scale ▶ ease of adjustment

NO MATTER IF FEED CONCENTRATION VARIES

The Flottweg Tricanter® discharges the heavy liquid through an adjustable impeller under pressure and the light phase by gravity. The variable impeller allows for precise on-the-fly adjustment of the pond

depth and liquid-liquid separation zone. This optimizes the purity of the liquids and may eliminate downstream equipment.



Feed and discharge devices with control lever for the adjustable impeller of the Flottweg Tricanter®

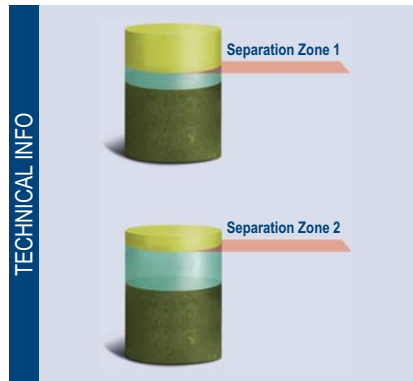

No matter if feed concentration varies: Best separation results with the Flottweg Tricanter® System



FLOTTWEG PRODUCT FEATURES

Customer Benefits by Using Flottweg Equipment



SIMP DRIVE®: SIMPLE, INTELLIGENT, MODULAR AND POWERFUL

The Simp Drive® regulates the differential speed between the decanter bowl and scroll depending on the prevailing scroll torque. The differential speed determines the dwell time the solids remain in the bowl, and thus has a significant influence on the separation performance. The bowl speed and differential speed can be adjusted independently of one another during ongoing operation. This is provided by the special transmission mechanism of the Simp Drive® (special planetary epicyclic gear unit).



WEAR PROTECTION

An optimum wear protection is crucial when using a decanter or Tri-canter® for many applications. All wear parts are protected by special hard surfaces utilizing tungsten carbide or SiC, as well as replaceable wear bushings. Under operating conditions, the Flottweg Wear Protection lasts more than 15,000 operating hours (depending on applications).

Replaceable wear protection elements

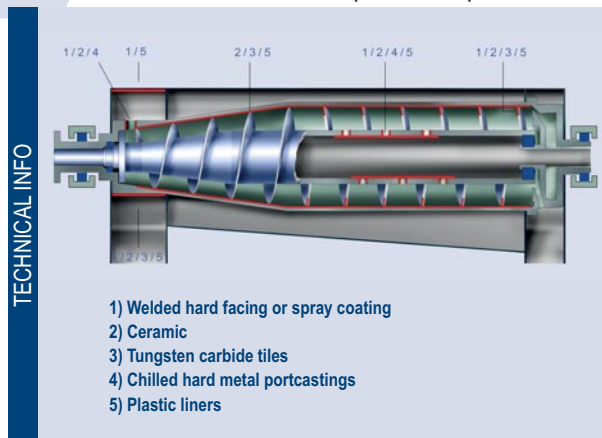

Customer benefits of the Flottweg Simp Drive®

- High flexibility in selection of the operating speed (differential speed can also be perfectly adjusted)
- High throughput performance due to high bowl speed and precisely adjusted differential speed
- Simp Drive® for a broad range of applications in which continuous adaptation of the operating parameters is required
- Lower energy requirements than conventional gear units due to higher efficiency (cost-saving)
- Machine can be cleared out even at no bowl rotation, because the scroll can nevertheless still be turned (no need to dismantle system components)

Customer benefits of the Flottweg Wear Protection

- Increased temperature resistance
- Improved corrosion resistance
- High hardness and protection
- Enhanced surface characteristics
- Improved durability of the decanter
- Increased consistency and reliability of the process



LUBRICATION

Various customer requirements demand different lubrication systems, to ensure a long service life and problem-free processes in Flottweg Decanter Centrifuges. Maintenance overhead (operating modes such as continuous operation, seasonal use, etc.) determines the selection of a lubrication system. The availability of the different lubrication systems also depends on the centrifuge model. Regardless these requirements, Flottweg provides unique customer benefits by offering different lubrication systems. These systems are listed below and are the following:

- Manual grease lubrication
- Central lubrication systems
- Automatic grease lubrication system
- Automatic oil/air lubrication system

Customer benefits of the Flottweg Lubrication

- Lowest maintenance cost, since the grease gun can be used for multiple decanters (manual grease lubrication)
- Cost savings and environmental protection with optimum correct doses (central lubrication)
- Continual monitoring of the fill level (automatic grease lubrication)
- Always fresh oil and air at the lubrication points (oil/air lubrication)



The picture shows a replaceable bushing

FLOTTWEG SEPARATION TECHNOLOGY – ENGINEERED FOR YOUR SUCCESS

Flottweg has been developing and producing centrifuges for more than 60 years including more than 40 years of successfully providing high-end machinery for the recovery of oil. Flottweg convinces customers all over the world with an unique experience as well as an outstanding expertise, especially when it comes to applying and using separation technology for the purpose of processing avocado.

Even more, by using Flottweg Systems and Equipment, customers receive significant and unique benefits in comparison to other providers of mechanical separation equipment or systems.

The Flottweg benefits for the processing of avocado

- Maximum oil yield due to appropriate machine design adapted to market requirements
- Tailor-made Flottweg Systems for avocado oil processing together with partners all over the world
- Automatic and continuous operation even at varying feed composition with a Flottweg Tricanter®
- The Flottweg Separator with Soft Shot® discharge system for solid discharge operations that make hardly any noise
- More than 100 different edible oil references
- Flottweg Products are designed and manufactured in Germany. That symbolizes high-quality, durability and efficiency.
- Service and customer service at Flottweg are known for their competence, speed and availability at fair conditions. These three words aren't just bullet points - they define our obligation to our customers.



TECHNICAL DATA

Decanter C-Series, Z-Series and Tricanter®

Decanter

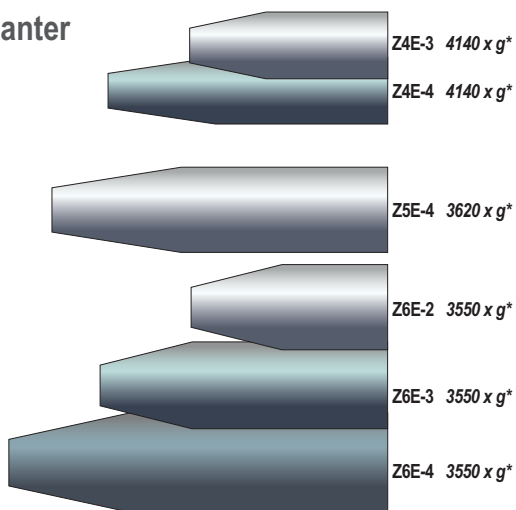

Decanter C-Series

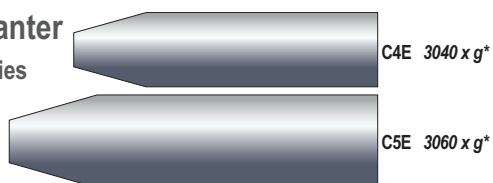

Tricanter®

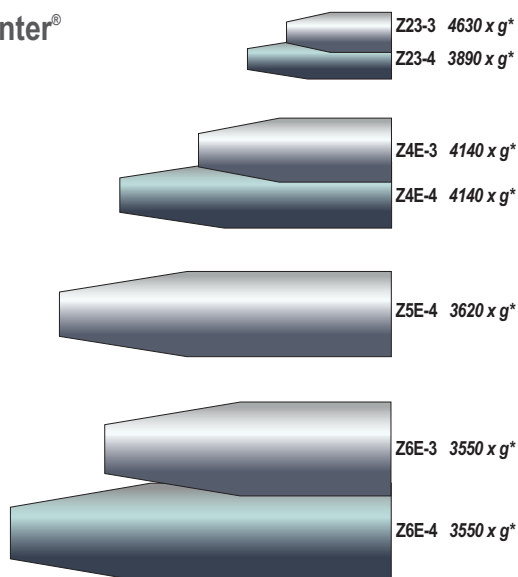

*Acceleration in g, depending on the temperature and the density of the product

Flottweg Decanter Centrifuges (Decanters and Tricanter®) for the extraction of avocado oil are available in 11 sizes for different capacities. So Flottweg offers you the right size combined with unique customer support. Please contact us via

- phone: +49 8741 301 0
- fax: +49 8741 301 300
- email: mail@flottweg.com
- www.flottweg.com

...and let's be successful together!



Flottweg Separation Technology – Engineered For Your Success



Flottweg SE
Industriestraße 6-8
84137 Vilsbiburg
Deutschland (Germany)

Tel.: +49 8741 301-0
Fax: +49 8741 301-300

mail@flottweg.com
www.flottweg.com

REPRESENTATIVE